Wheel – Description of how it is made

DMC: S1000DBIKE-AAA-DA0-00-00-00AA-041A-A
Language: en/US
Issue No.: 008
Issue Date: 2012-12-31
Title: Wheel – Description of how it is made
Security Classification: UNCLASSIFIED

Data Restrictions

Distribution: To be made available to all S1000D users.
Export Control: Export of this data module to all countries that are the residence of organizations that are users of S1000D is permitted. Storage of this data module is to be at the discretion of the organization.
Handling: There are no specific handling instructions for this data module.
Destruction: Users may destroy this data module in accordance with their own local procedures.
Disclosure: There are no dissemination limitations that apply to this data module.
Copyright: **Copyright (C) 2013** by each of the following organizations:

- AeroSpace and Defence Industries Associations of Europe - ASD.
- Ministries of Defence of the member countries of ASD.

Limitations of Liability:

- This material is provided "As Is" and neither ASD nor any person who has contributed to the creation, revision or maintenance of the material makes any representations or warranties, express or implied, including but not limited to, warranties of merchantability or fitness for any particular purpose.
- Neither ASD nor any person who has contributed to the creation, revision or maintenance of this material shall be liable for any direct, indirect, special or consequential damages or any other liability arising from any use of this material.
- Revisions to this document may occur after its issuance. The user is responsible for determining if revisions to the material contained in this document have occurred and are applicable.

Policy reference: TPSMG TOR 001

Conditions: There are no known conditions that would change the data restrictions for, or security classification of, this data module.

Responsible partner company: UK MoD /U8025

Originator: UK MoD /U8025

Applicability cross-reference table reference: [S1000DBIKE-AAA-D00-00-00-00AA-00WA-D](#)

Applicability: Mountain bicycle and (Mountain storm Mk1 or Brook trekker Mk9)

Applicable to: Mountain bicycle
and (Mountain storm Mk1 or
Brook trekker Mk9)

S1000DBIKE-AAA-DA0-00-00-00AA-041A-A

Technical standard: Authority information: 20010131
Authority baseline: Bike book
Authority exceptions:
Authority notes:

Brex data module reference: [S1000DBIKE-AAA-D00-00-00-00AA-022A-D](#)

QA: First verification Cleared Table Top

System breakdown code: BY

Skill level: Basic

Reason for updating: Page Layout Measurement Unit Consistency
CPF 2009-060US

Wheel

Description of how it is made

Table of contents

	Page
Description of how it is made	1
References	1
Description	1
1 The bicycle wheel	1
1.1 Spokes	3
1.2 Wheel rim	3
1.3 Tube and tire	5

List of tables

1	References	1
---	------------------	---

List of figures

1	Parts of the wheel	2
2	The tire and rim	4
3	Valve	6

References

Table 1 References

Data module / Technical publication	Title
None	

Description

1 The bicycle wheel

The wheel (refer to [Fig 1](#)) of a bicycle is a complex structure. The wheel assembly has these parts:

- the tire
- the tube
- the spokes
- the spoke nipples
- the valve
- the hub

On their own, the individual components are not very strong. But, when they are installed together, the components make the complete wheel (refer to [Fig 1](#)). The complete wheel is resistant to almost any type of heavy loads and operation.

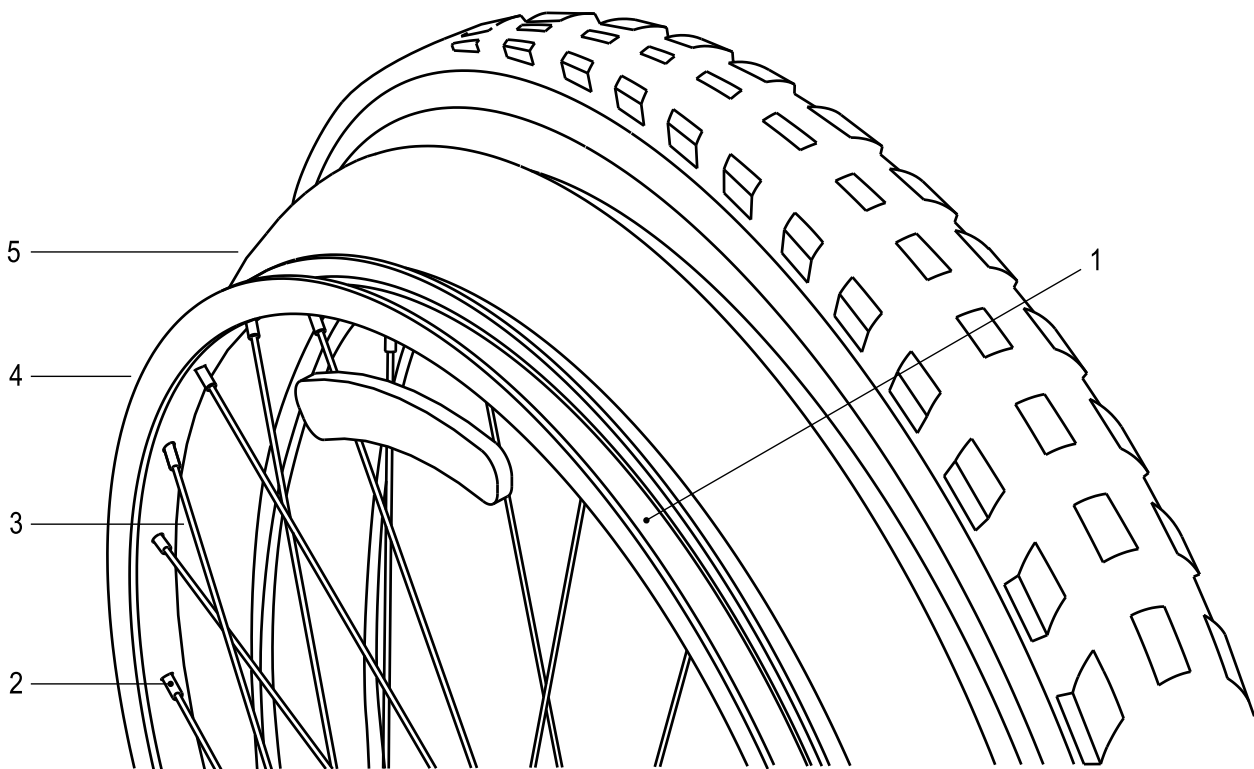
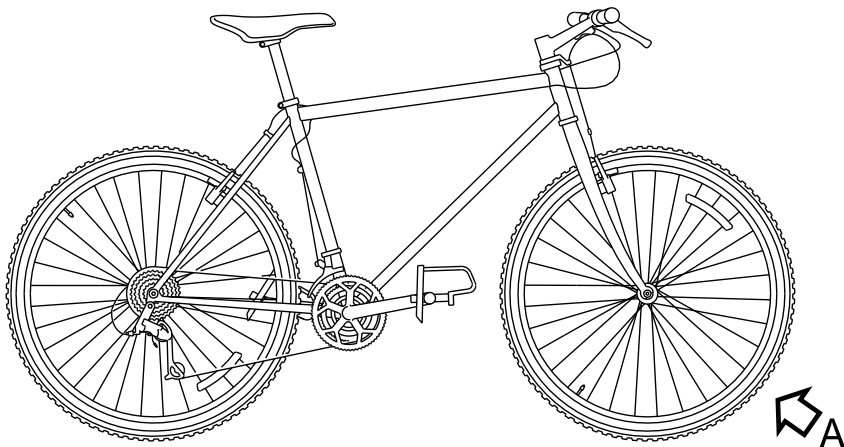

A

ICN-S1000DBIKE-AAA-DA00000-0-U8025-00504-A-04-1

Fig 1 Parts of the wheel

1.1 Spokes

The spokes go out from the hub and go across and below each other. The spoke nipples attach the spokes to the rim with the threads on the end of the spokes. You can use the spoke nipples to adjust the tension of the spokes. The tension on each of the spokes must be equal.

1.2 Wheel rim

The rim (refer to [Fig 2](#)) of the wheel has a lining of rim tape. This tape protects the tube from damage that the rough edges on the spoke nipples can cause.

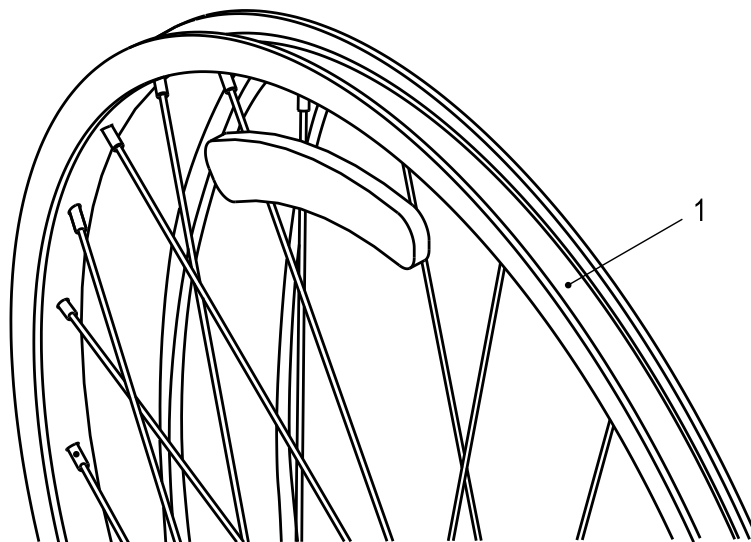
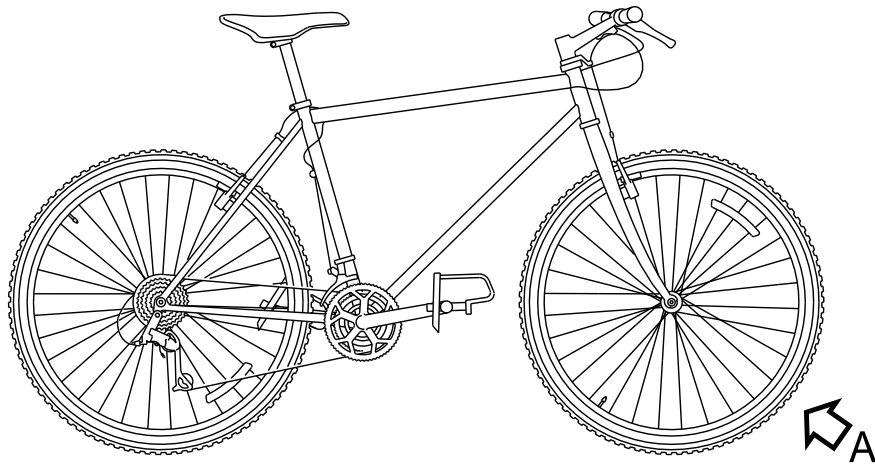

A

ICN-S1000DBIKE-AAA-DA00000-0-U8025-00504-B-04-1

Fig 2 The tire and rim

1.3 Tube and tire

The tube and the tire install on the rim. The sidewalls of the tire have markings on them. These which are used to indicate the correct direction of rotation. The markings also make sure the tire installs on the rim and that the directional arrows points in the correct direction. You install the tube into the tire before you inflate it. The tube has a valve (refer to [Fig 3](#)) which you put through the hole in the rim. This valve (refer to [Fig 3](#)) is used to inflate the tube and the tire to the correct pressure. A dust cap installs on the valve (refer to [Fig 3](#)) to prevent damage that dust and debris can cause.

The tube and the tire install on the rim. The sidewalls of the tire have markings on them. These which are used to indicate the correct direction of rotation. The markings also make sure the tire installs on the rim and that the directional arrows points in the correct direction. You install the tube into the tire before you inflate it. The tube has a valve (refer to [Fig 3](#)) which you put through the hole in the rim. This valve (refer to [Fig 3](#)) is used to inflate the tube and the tire to the correct pressure. A dust cap installs on the valve (refer to [Fig 3](#)) to prevent damage that dust and debris can cause.

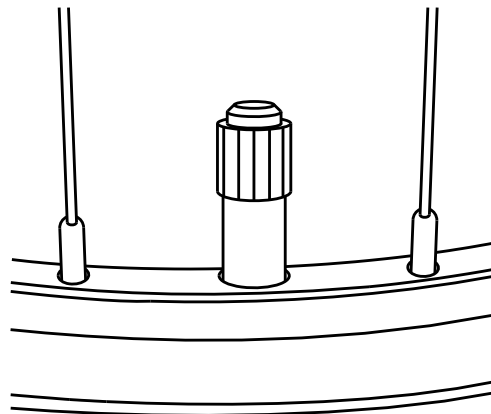
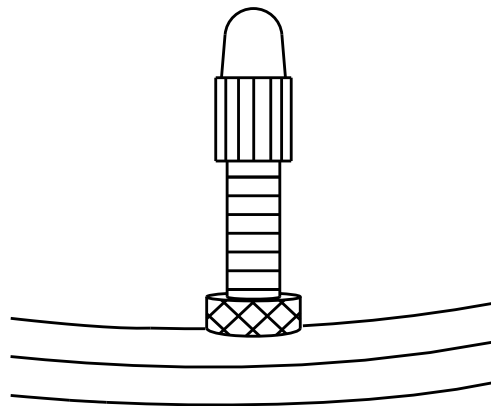
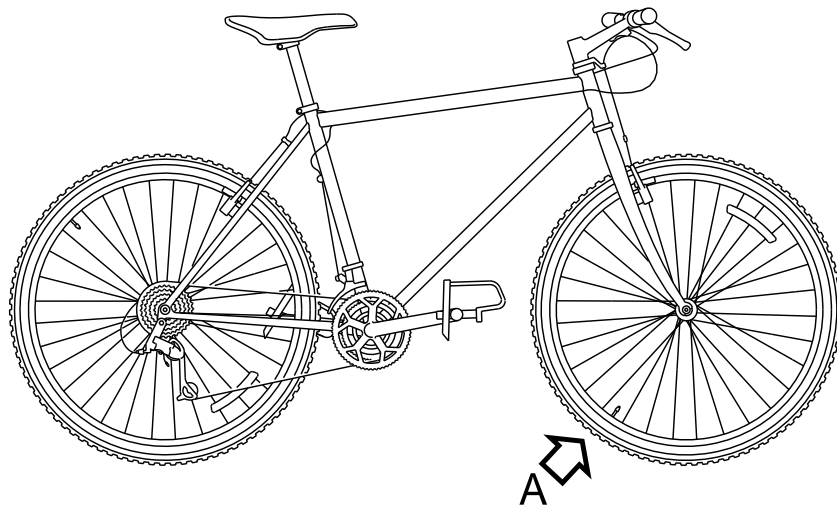

A

ICN-S1000DBIKE-AAA-DA00000-0-U8025-00505-A-04-1
Fig 3 Valve